

Kymera 193i

Imaging spectrograph

Intelligent, modular and compact spectrograph for **Physical** and **Life** science

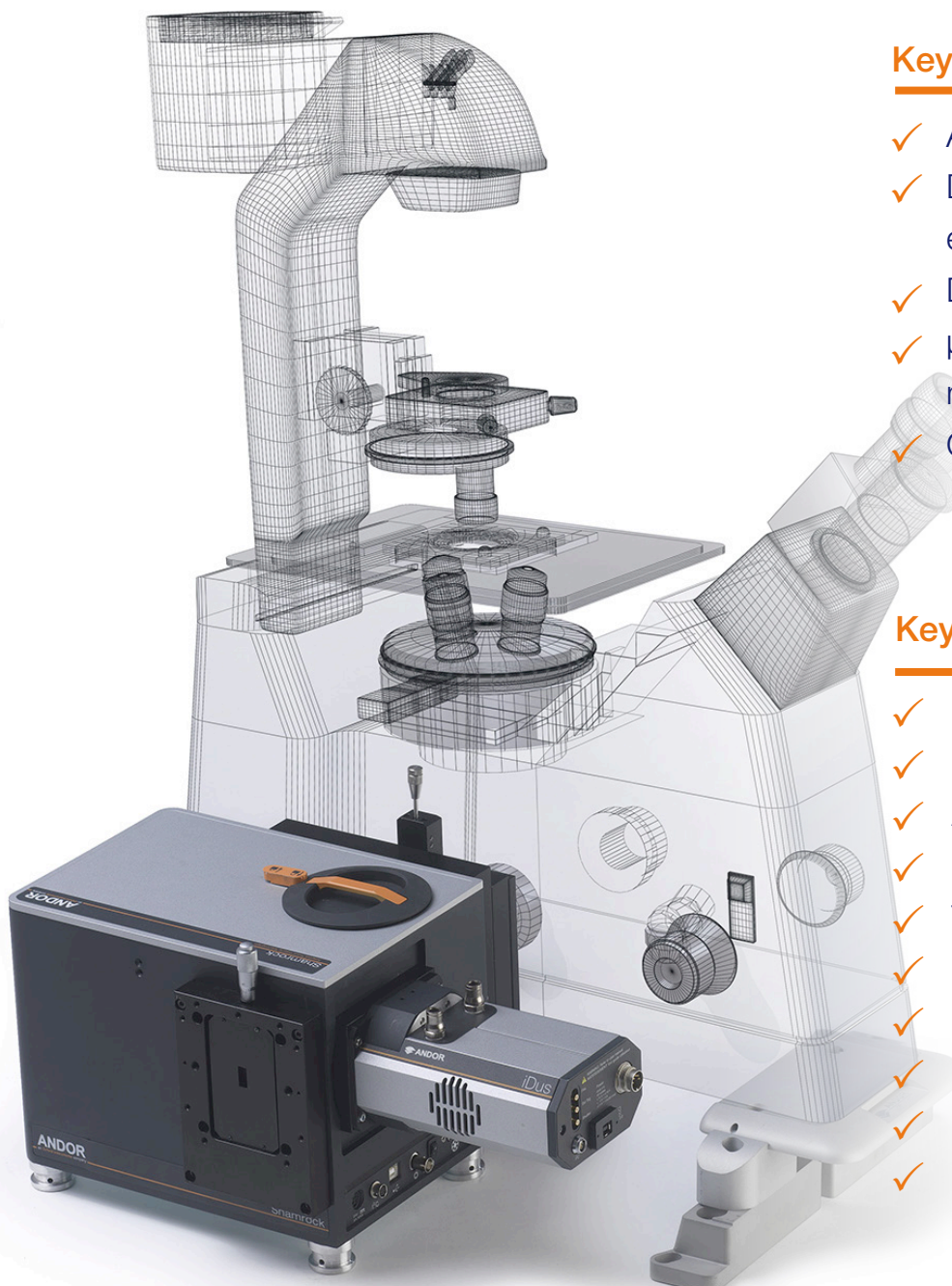

Key Specifications

- ✓ Adaptive Focus (patented)
- ✓ Dual-grating turret with eXpressID™
- ✓ Dual detector outputs
- ✓ μ -Manager software for microspectroscopy
- ✓ Compact and easy to integrate

Key Applications

- ✓ Raman
- ✓ Luminescence
- ✓ Absorption
- ✓ Non-linear optics
- ✓ Transient spectroscopy
- ✓ Microspectroscopy
- ✓ Material Science
- ✓ Chemistry
- ✓ Biomedical
- ✓ Plasma Studies

1 Dual Exit Ports



Versatile and flexible configurations for wide range of spectroscopy measurements.

Dual port setups include various combinations of:

- CCD cameras for UV, Vis and NIR spectroscopy
- ICCD cameras for UV to NIR and Time Resolved measurements
- Single Point Detectors (SPDs) for scanning spectroscopy solutions from UV to SWIR
- SPDs for time resolved, lifetime measurements
- Exit slits for monochromator tunable light source
- Fiber coupling to deliver output light/signal to another part of experiment

The ports are easily selected through the software and integrity of calibration for each port is independent and well maintained.



2 Adaptive Focusing (patented*)



Automated optimization for the best quality of focus:

- Ensures the best resolution at any wavelength
- Automatic optimization when changing between gratings, or cameras
- Software-controlled, easy to switch on and off when required
- No need for tedious adjustment of camera position at the exit ports

*Adaptive Focus Technology, patent WO2016012794 A3

Adaptive Focus: Automated scan provides optimum focus

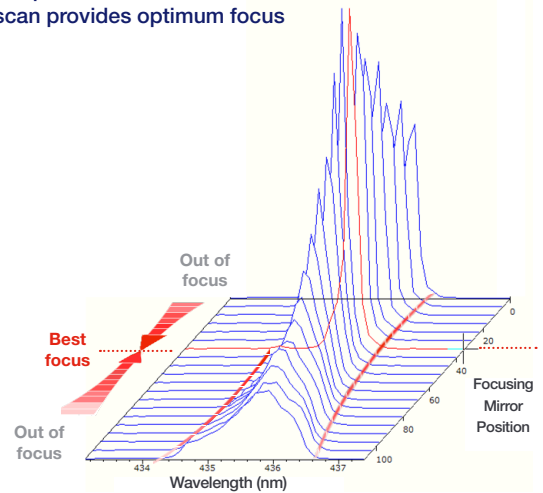

3 μ -Manager Control

μ Manager

User-friendly simultaneous access to Andor Kymera 193i, low-light spectroscopy cameras and a wide range of microscopes and microscope accessories. Andor's dedicated interface allows seamless spectral acquisition, display and manipulation, as well as facilitating 'spectral' mapping sequences with advanced metadata handling.

5 simple steps to set up your microspectroscopy experiment

1. Set up spectrograph
2. Set up camera
3. Set up microscope
4. Set up experiment e.g. X-Y-Z chemical mapping
5. Display spectral data in real time & save acquisition series

Features and Benefits

| Feature | Benefit |
|---|---|
| 193 mm focal length, F/3.6 aperture | Ideal combination for a wide range of applications, ranging from luminescence/ photoluminescence spectroscopy, to more demanding, higher resolution Raman spectroscopy. |
| Adaptive Focus (patented) | Intelligent and user-friendly interface, for uncompromised spectral resolution performance. |
| Dual-grating turret with xPressID™ RFID technology | Seamless field-upgradability with precise indexing interface, and user-friendly hatch access. Automatic gratings recognition and setup, with embedded RFID tags - minimum user interaction. |
| Astigmatism-corrected optical design | Toroidal optics enable multi-track fiber detection and excellent sample image relay from a microscope at the grating '0' order. |
| Dual outputs | Extended wavelength coverage when combining Andor UV-NIR CCD, EMCCD, ICCD and InGaAs cameras. Slit option for monochromator operation. |
| USB interface | Plug-and-play connectivity, ideal for laptop operation alongside Andor USB cameras. |
| Seamless connection to microscopes | Adjustable height feet and choice of direct, lens relay, or cage system-based interfaces. 15 mm wide-aperture input slit for extended sample image relay and spectral analysis through the same optical path. |
| Protected silver-coated optics option | Most efficient for NIR/SWIR detection when used in conjunction with Andor InGaAs cameras. |
| Pre-aligned, pre-calibrated instrument | Individually characterized spectrograph-detector systems for out-of-the box operation. |
| High repetition rate shutter | 10 Hz continuous operation and 40 Hz burst mode for ultrafast background acquisition and detector protection. |
| μ-Manager software integration | Simultaneous control of Andor cameras and spectrographs, and a wide range of microscopes and accessories through 1 single software platform. Dedicated, user-friendly spectrum handling interface. |
| Monochromator capabilities | Extract the best optical resolution while allowing use of single point detectors with sensitivity up to 12 μm (Labview SDK-based solution only). |
| Integrated in EPICS *20 | Integration and operation at EPICS-based large research facilities. |
| Compact and rugged design | Ideal for integration into OEM instruments, or space constrained setups. |

The Kymera 193i in key numbers

Resolution with Newton DU940 CCD

1200 l/mm @ 500 nm 0.21 nm

2400 l/mm @ 300 nm 0.10 nm

| | |
|--|--|
| Aperture | F/3.6 |
| Focal length | 193 mm |
| Magnification (Vertical @ centre of | 1.07 |
| Gratings | Interchangeable dual on-axis RFID-tagged turret for easy swapping |
| Communication | USB 2.0 |
| Wavelength accuracy centre | 0.15 nm |
| Wavelength repeatability | 75 μm |

Step-by-Step System Configuration

How to customize the Kymera 193i:

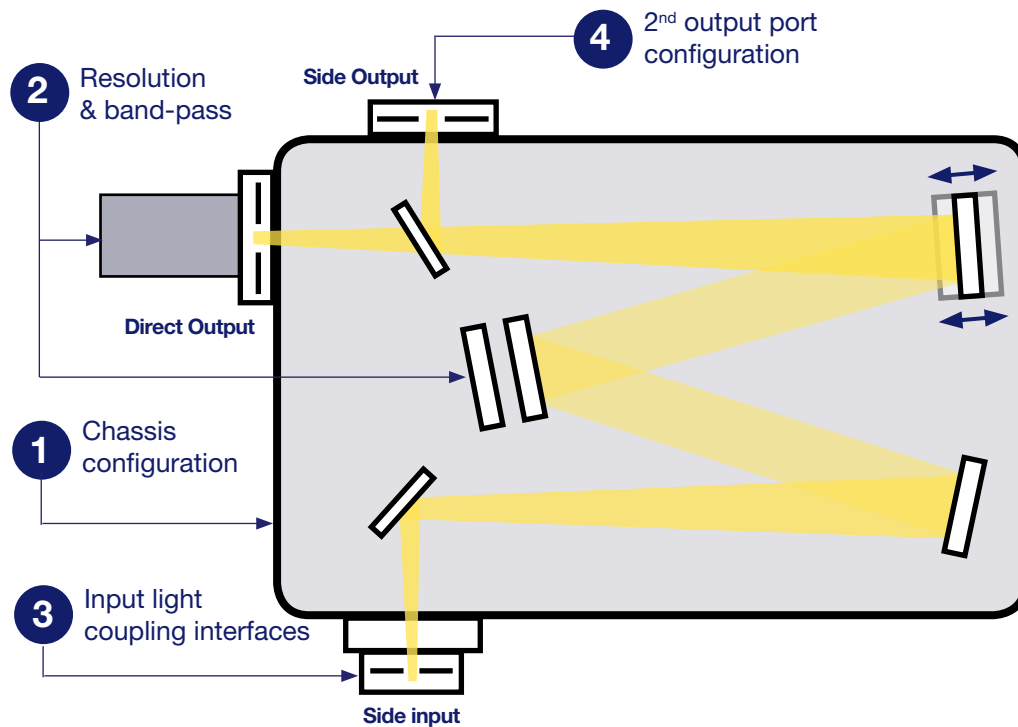

1 Chassis configuration

- a) Select combination of input and output ports (see page 5 for available options).
- b) Select type of optics coating required (aluminium + MgF₂ is standard, protected silver coated optics available on request, for NIR detection).
- c) Select purge port option (for improved detection down to 180 nm). Shutter for background acquisition and protection of the detector.

2 Resolution & band-pass

Select gratings and detector to fulfil resolution and wavelength requirements.

3 Input light coupling interface

Refer to accessory tree for available configurations (direct coupling, fibre coupling or 3rd party hardware connectivity).

4 2nd exit port configuration

Refer to accessory tree for available configurations, including camera flanges.

5 Software interface

Select either state-of-the-art Solis software or Software Development Kit (SDK) option – please refer to the appropriate section for further information.

Step 1 - Chassis Configuration

Ordering Information

| Model | Side input port | Direct output port | Side output port | Motorized port selection |
|-------------------|--|--------------------|------------------|--------------------------|
| KYMER-193i-A | Manual slit | Camera | - | - |
| KYMER-193i-B1 | Manual slit | Camera | Manual slit | ✓ |
| KYMER-193i-B2 | Manual slit | Camera | Camera | ✓ |
| KYMER-193i-xx-SIL | Protected silver-coated optics options for models shown above (replace x with relevant model number) | | | |

Optics Coatings Reflectivity Graph

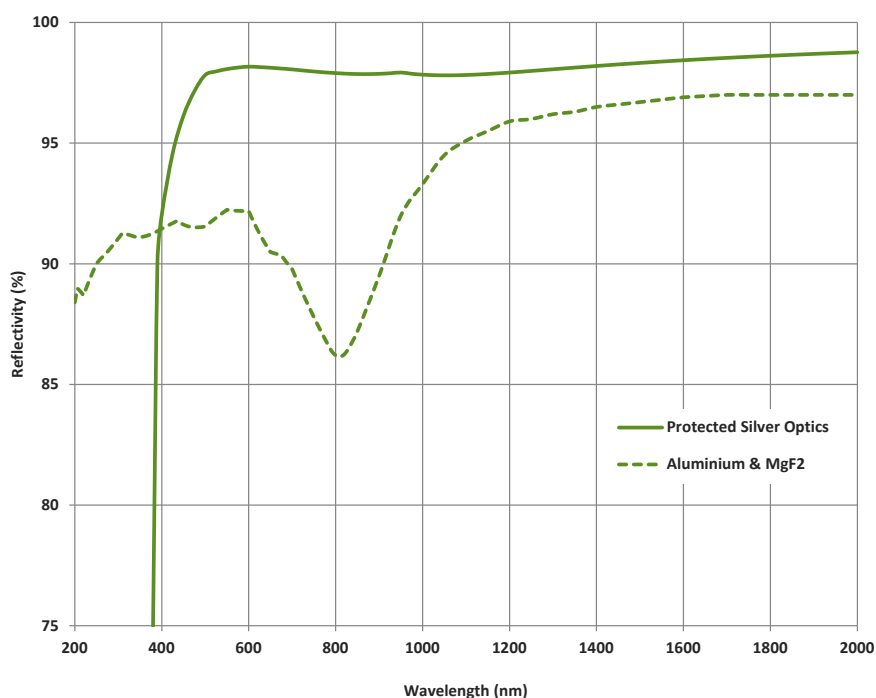

Standard systems use Al + MgF₂ coated optics. Protected silver optics are also available on request for maximum efficiency in the NIR region - recommended for working with Andor iDus InGaAs detectors or IR single-point detectors, such as MCT, PbS and InSb.

When choosing protected silver coatings, it is strongly recommended to also order **protected silver coated gratings** for maximum efficiency throughout the system.

Chassis Accessories

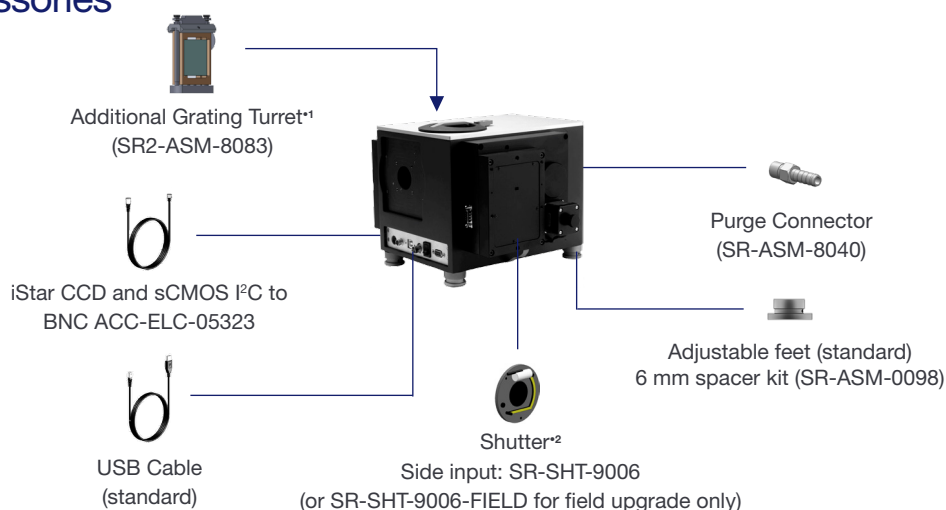

Step 2a - Choosing The Right Platform vs Dispersion Requirements

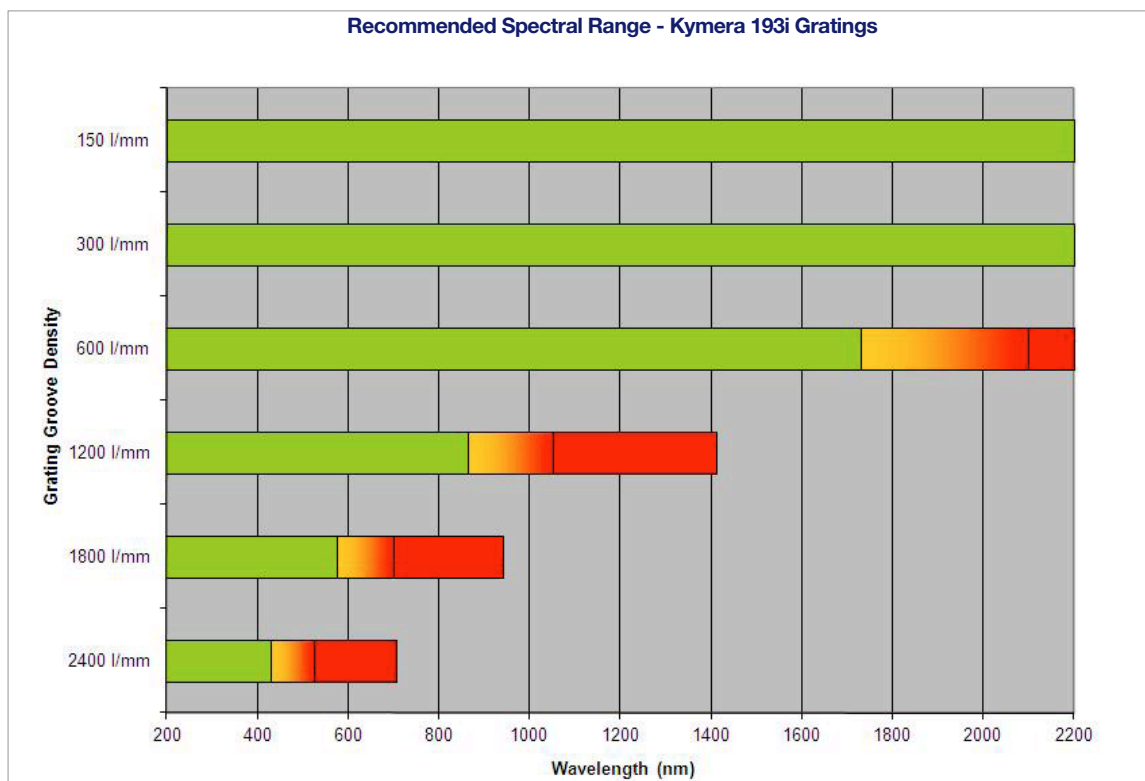

Resolution calculator

andor.com/calculators

- Green**
Aberration-free region
- Orange**
Possible impact on system resolution
- Red**
Likely impact on system resolution

Czerny-Turner spectrographs are designed to provide the best optical performance for a range of grating angles as reflected on the green parts of the graph above. Outside this range, the spectral lines may exhibit a degree of optical aberration (such as coma), which will become more prominent at the steeper angles. These configurations are reflected by the orange to red scales on the graph. In these regions, consideration should be given to higher spectrograph focal length models with lower groove density gratings to achieve the desired resolution.

| | Grating (l/mm) | | | | | |
|----------------------------------|----------------|-----------|-----------|-----------|-------------|-------------------------|
| | 150 | 300 | 600 | 1200 | 1800 (Holo) | 2400 (Holo) |
| Shamrock 163 | | | | | | |
| Bandpass (nm) ^{*3,*5} | 1072 | 529 | 256 | 117 | 68 | 56 ^{*6} |
| Resolution (nm) ^{*4,*5} | 2.33 | 1.15 | 0.55 | 0.25 | 0.15 | 0.13 ^{*6} |
| Kymera 193i | | | | | | |
| Bandpass (nm) ^{*3,*5} | 902 | 445 | 215 | 98 | 56 | 46 ^{*6} |
| Resolution (nm) ^{*4,*5} | 1.96 | 0.96 | 0.47 | 0.21 | 0.12 | 0.10 ^{*6} |
| Kymera 328i | | | | | | |
| Bandpass (nm) ^{*3,*5} | 542 | 268 | 131 | 61 | 41 | 29 ^{*6} |
| Resolution (nm) ^{*4,*5} | 0.88→0.62 | 0.44→0.31 | 0.21→0.15 | 0.10→0.07 | 0.06→0.04 | 0.05→0.04 ^{*6} |

Where aberration is a concern for a particular experimental set-up, the table above shows resolution and band-pass performance for a variety of alternative configurations. This should be used in conjunction with the graph above to assist in selecting the most appropriate spectrograph platform to meet resolution and band-pass needs, whilst minimising the risk of potential aberration.

Have you found what you are looking for?

Need higher spectral resolution? The Shamrock spectrograph family also offers half and three-quarter meter focal length motorized platform.

Need extended multi-track capabilities? The HoloSpec offers unique high-density multi-fibre acquisition with ultra-low crosstalk.

Need higher collection efficiency? The HoloSpec offers a unique F/1.8 aperture and high transmission optics for maximum throughput.

Step 2b - Choosing The Right Grating vs Resolution and Band-pass

The Kymera 193i features a dual grating turret, designed to offer flexibility and control over your choice and interchange of gratings. The dual grating turret can be easily and speedily removed, and replaced by an alternative turret with new gratings. The intelligent design of the 193i means that only a simple offset adjustment is required once the new turret and gratings are added. The 193i is shipped with the grating turret already in place, ensuring your system is ready for use straight out of the box. Additional grating turrets are available with up to two pre-installed gratings (see below for details). If the grating you require is not on the list, please contact Andor for further details. Additional grating turrets (part number SR2-ASM-8083) can also be supplied on request.

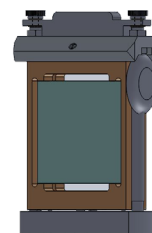

| Lines/mm | Blaze (nm) | Nominal dispersion (nm/mm) ^{*7} | Bandpass (nm) ^{*3,*7} | Resolution (nm) ^{*4,*7,*10} | Peak efficiency (%) | Andor part number | Maximum recommended wavelength [nm] ^{*9} |
|----------|-------------------------------|--|--------------------------------|--------------------------------------|---------------------|-------------------|---|
| 150 | 300 | 32.80 | 907 | 1.97 | 72 | SR2-GRT-0150-0300 | 6820 |
| 150 | 500 | 32.63 | 902 | 1.96 | 73 | SR2-GRT-0150-0500 | |
| 150 | 800 | 32.35 | 894 | 1.94 | 80 | SR2-GRT-0150-0800 | |
| 150 | 1250 | 31.90 | 882 | 1.91 | 84 | SR2-GRT-0150-1250 | |
| 150 | 2000 | 31.07 | 859 | 1.86 | 88 | SR2-GRT-0150-2000 | |
| 300 | 300 | 16.27 | 450 | 0.98 | 88 | SR2-GRT-0300-0300 | 3410 |
| 300 | 500 | 16.08 | 445 | 0.96 | 81 | SR2-GRT-0300-0500 | |
| 300 | 1000 | 15.53 | 429 | 0.93 | 72 | SR2-GRT-0300-1000 | |
| 300 | 1200 | 15.29 | 423 | 0.92 | 92 | SR2-GRT-0300-1200 | |
| 300 | 1700 | 14.59 | 403 | 0.88 | 89 | SR2-GRT-0300-1700 | |
| 600 | 300 | 7.99 | 221 | 0.48 | 84 | SR2-GRT-0600-0300 | 1705 |
| 600 | 500 | 7.77 | 215 | 0.47 | 72 | SR2-GRT-0600-0500 | |
| 600 | 1000 | 7.06 | 195 | 0.42 | 72 | SR2-GRT-0600-1000 | |
| 600 | 1200 | 6.72 | 186 | 0.40 | 88 | SR2-GRT-0600-1200 | |
| 600 | 1900 (@1600) ^{*8} | 5.17 5.91 | 143 163 | 0.31 0.35 | 88 | SR2-GRT-0600-1900 | |
| 830 | 820 | 4.98 | 138 | 0.30 | 87 | SR2-GRT-0830-0820 | 1230 |
| 830 | 1200 | 4.17 | 115 | 0.25 | 83 | SR2-GRT-0830-1200 | |
| 1200 | 300 | 3.82 | 106 | 0.23 | 72 | SR2-GRT-1200-0300 | 850 |
| 1200 | 500 | 3.53 | 98 | 0.21 | 81 | SR2-GRT-1200-0500 | |
| 1200 | 1000 (@ 800) ^{*8} | 2.45 2.95 | 68 82 | 0.15 0.18 | 69 - | SR2-GRT-1200-1000 | |
| 1200 | Holographic (500 nm peak) | 3.53 | 98 | 0.21 | 81 | SR2-GRT-1200-EH* | |
| 1800 | Holographic (250 nm peak) | 2.48 | 69 | 0.15 | 70 | SR2-GRT-1800-DH | 570 |
| 1800 | Holographic (380 nm peak) | 2.28 | 63 | 0.14 | 62 | SR2-GRT-1800-FH | |
| 2400 | 300 | 1.68 | 46 | 0.10 | 68 | SR2-GRT-2400-0300 | 425 |
| 2400 | Holographic (220 nm peak) | 1.81 | 50 | 0.11 | 68 | SR2-GRT-2400-BH | |
| 2400 | Holographic (400 nm peak) | 1.48 | 41 | 0.09 | 73 | SR2-GRT-2400-GH | |

*Option for minimized scattered light.

Need to have maximum collection efficiency in the NIR/SWIR? All gratings are also available with protected silver coating. Please contact your local representative for further information.

Step 2c - Selecting The Correct Grating Efficiency Option

All graphs shown below represent efficiency for 45° polarisation

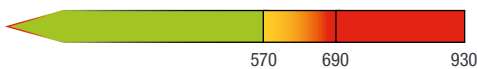
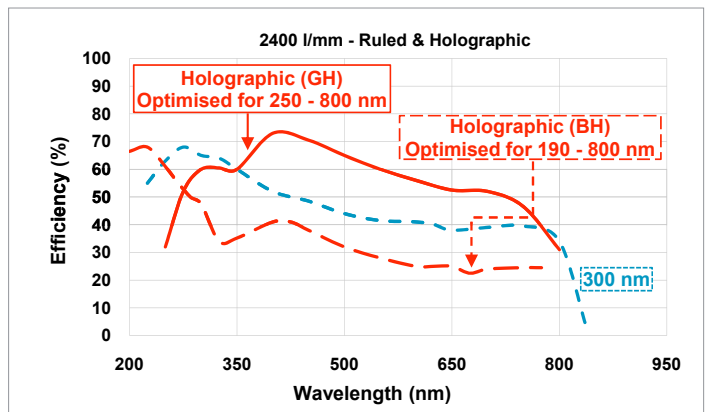
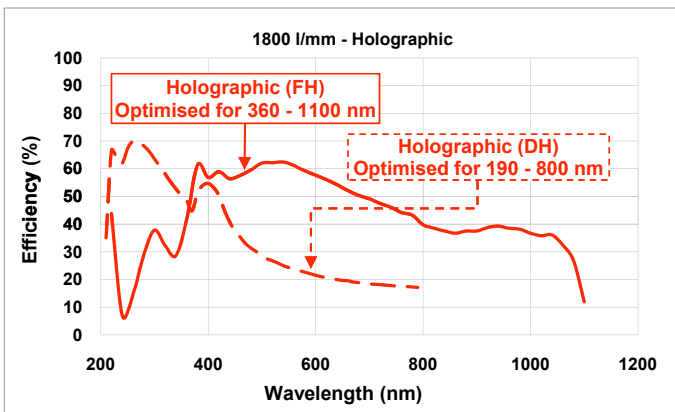
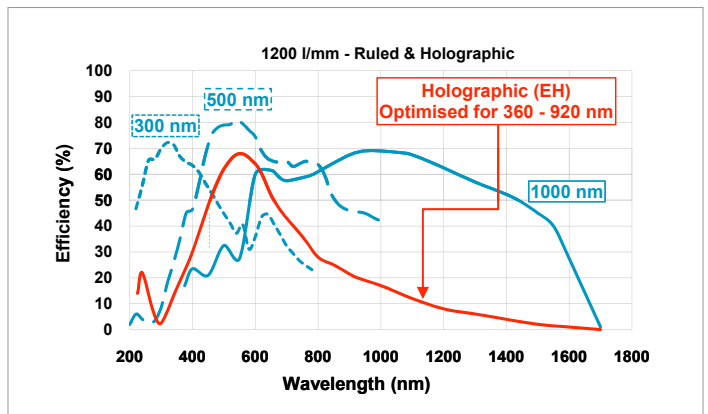
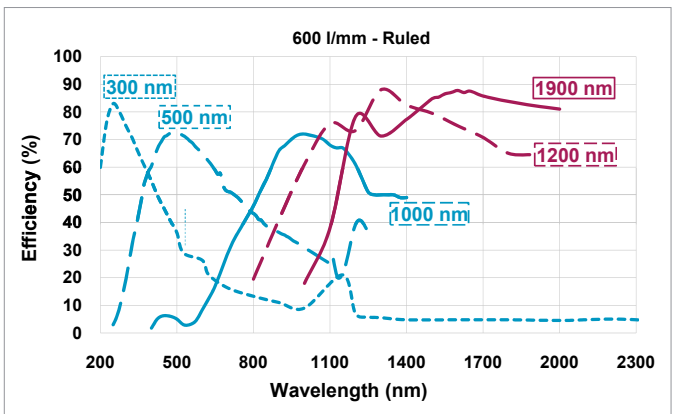
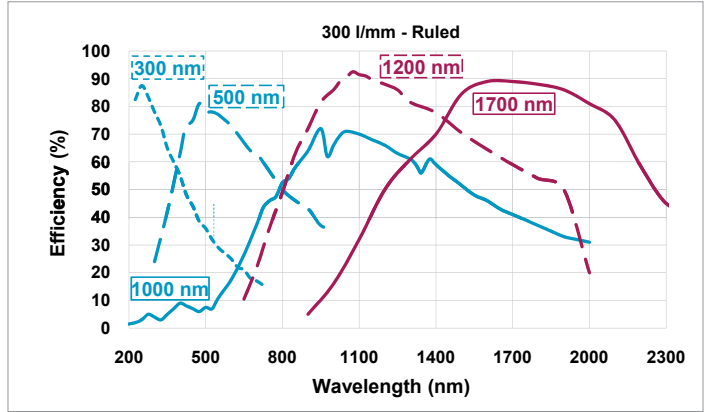
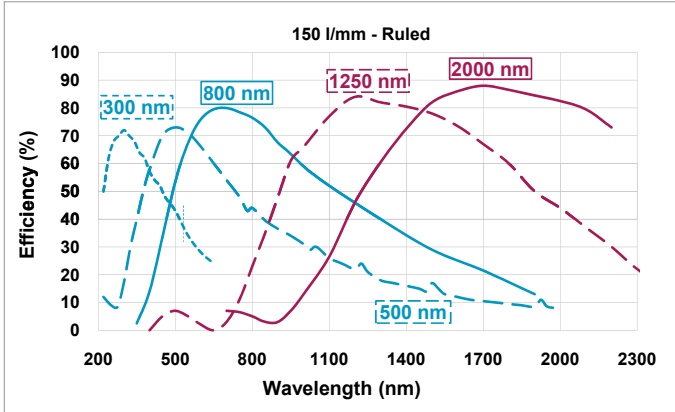

Important Consideration

System throughput is dependent on the grating's angle of operation and may decrease with higher grating operating angles.

Step 3 - Selecting The Correct Light Coupling Interfaces

Side input port (applicable to all models)

How to customize the Kymera 193i (Side Entrance Port):

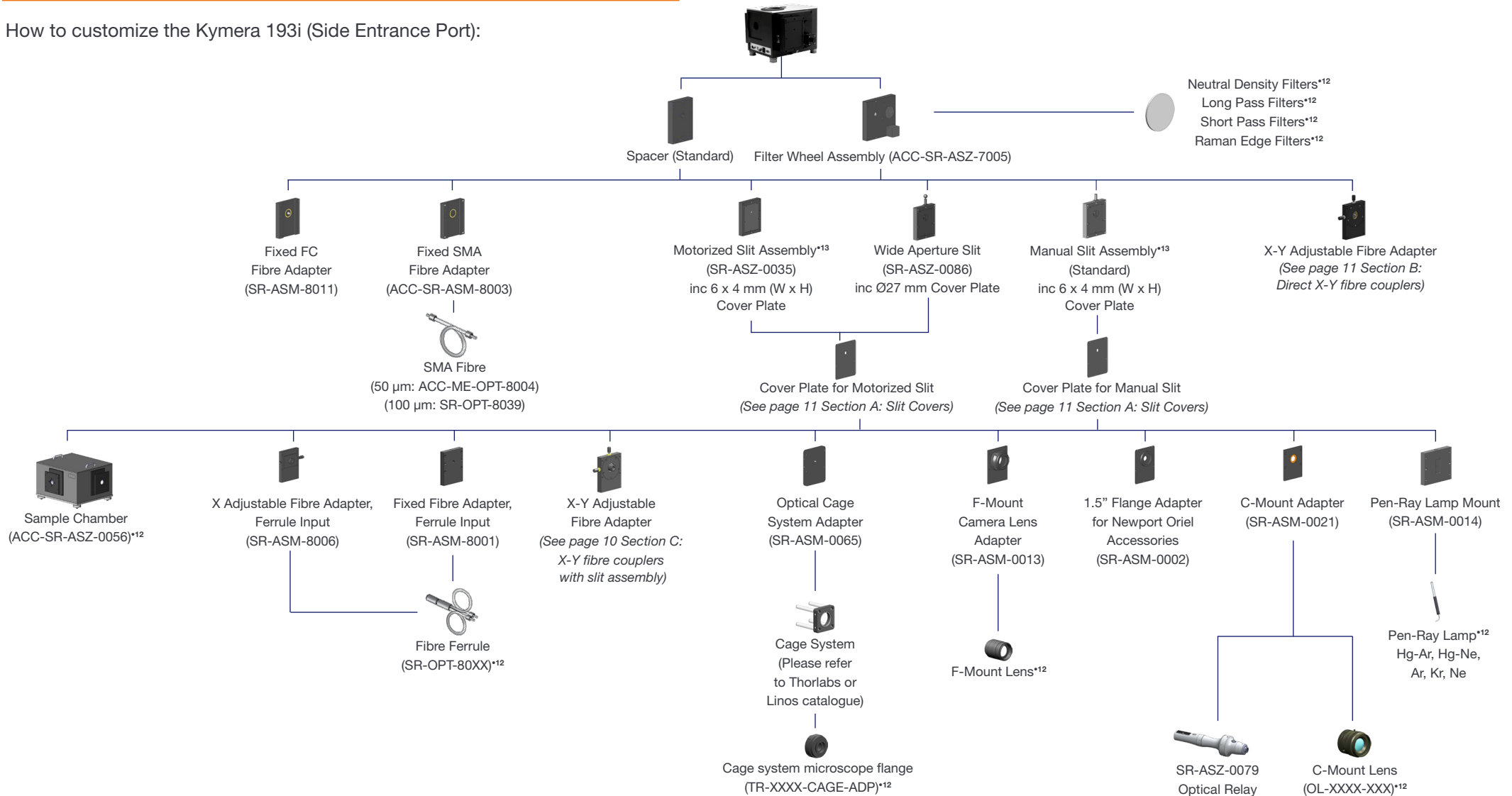

Step 4 - Cameras and Output Port Flanges

How to customize the Kymera 193i:

Side Output Port (Applicable to B models)

Note: This output is compatible with Andor Spectroscopy CCD and ICCD cameras- no mounting flange required.

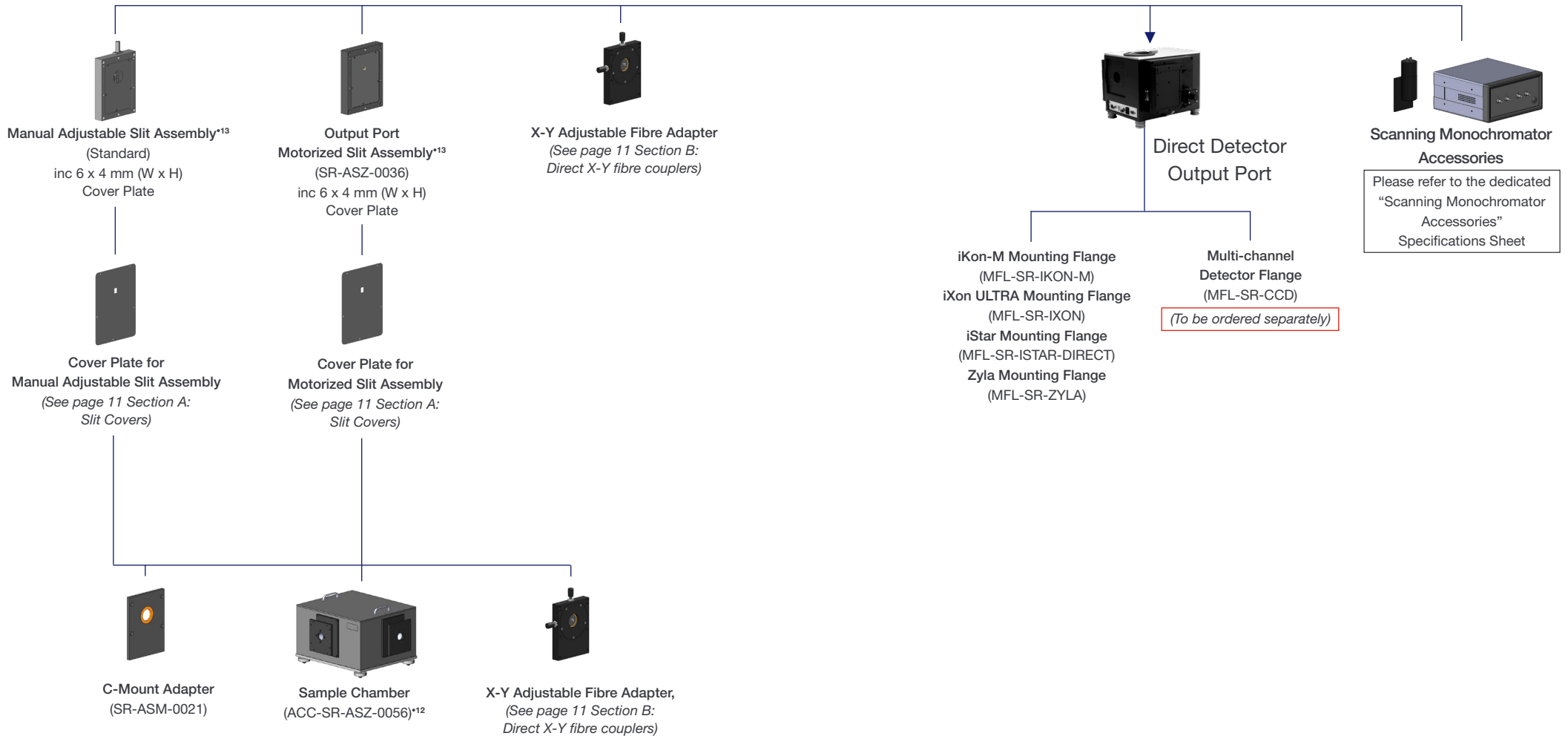

A: Slit Covers

Cover Plate Apertures for Motorized Slit

| Part No. | Size |
|----------------------------|-------------------|
| SR-ASM-0016 ^{*14} | 6 x 4 mm (W x H) |
| SR-ASM-0017 | 6 x 6 mm (W x H) |
| SR-ASM-0010 | 6 x 8 mm (W x H) |
| SR-ASM-0011 | 6 x 14 mm (W x H) |
| SR-ASM-0072 ^{*15} | Ø 27 mm |

Cover Plate Apertures for Manual Slit

| Part No. | Size |
|----------------------------|-------------------|
| SR-ASM-0025 | 6 x 4 mm (W x H) |
| SR-ASM-0026 | 6 x 6 mm (W x H) |
| SR-ASM-0027 | 6 x 8 mm (W x H) |
| SR-ASM-0028 | 6 x 10 mm (W x H) |
| SR-ASM-0029 ^{*14} | 6 x 14 mm (W x H) |
| SR-ASM-0100 ^{*15} | Ø 27 mm |

B: Direct X-Y Fibre Couplers

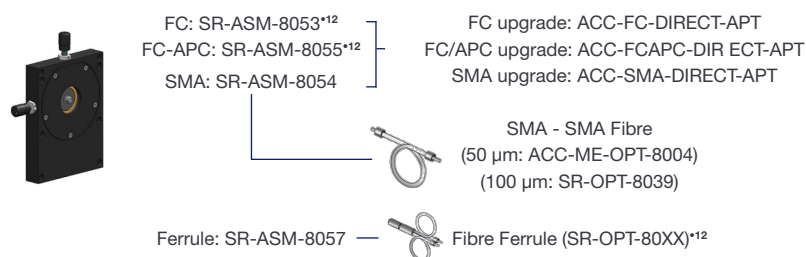

C: X-Y Fibre Couplers (with Slit Assembly)

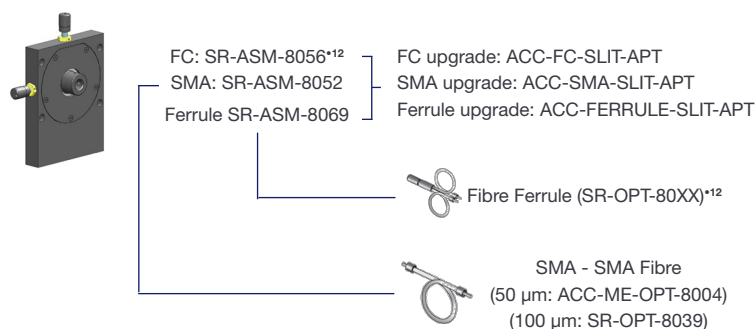

Notes:

- For connection to manual slits, please also order Ø27 mm slit cover plate SR-ASM-0100
- For connection to motorized slits, please also order Ø27 mm slit cover plate SR-ASM-0072

Step 5 - Selecting a Software Option

The Kymera 193i requires at least one of the following software options:

- 1 - **Solis Spectroscopy** A 32-bit and fully 64-bit enabled application for Windows (7, 8, 8.1 and 10) offering rich functionality for data acquisition and processing, as well as Andor cameras, spectrograph and motorized accessories simultaneous control. AndorBasic provides macro language control of data acquisition, processing, display and export.
- 2 - **Standalone Solis Spectroscopy** GUI for standalone spectrograph operation
- 3 - **Kymera and Shamrock SDK** A software development kit that allows you to control the Andor range of Kymera and Shamrock spectrographs from your own application. Compatible as 32-bit and 64-bit libraries for Windows (7, 8, 8.1 and 10). Compatible with C/C++, C#, VB.NET and LabVIEW for Windows/Linux
- 4 - **Solis Scanning** Dedicated interface for scanning monochromator acquisitions, including comprehensive experimental set-ups builder. Simultaneous control of single point detector Kymera and Shamrock monochromator and motorized accessories.

Solis Spectroscopy: Dedicated spectroscopy acquisition software

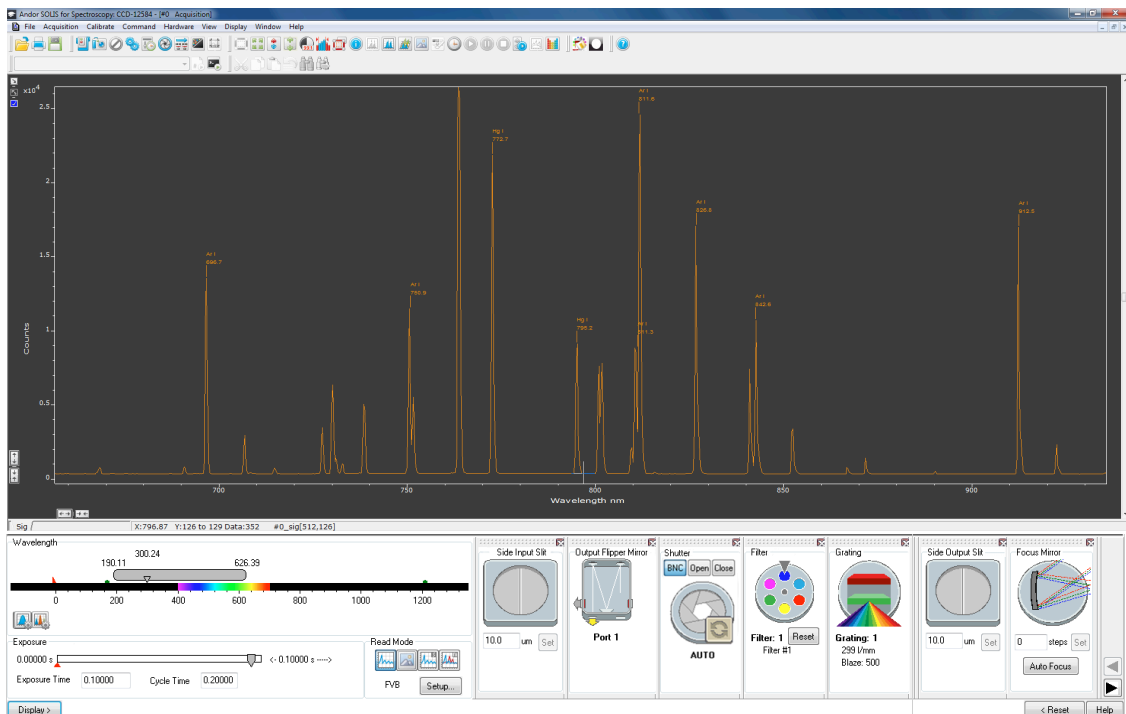

Wavelength drive

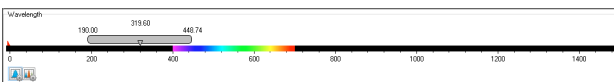

Set the wavelength of interest by dragging slider or typing the desired value. For step-and- glue, select wavelength range for extended bandpass and high resolution acquisition.

Exposure time



Set the exposure time for the detector - quick access for easy acquisition optimization.

Real Time Control

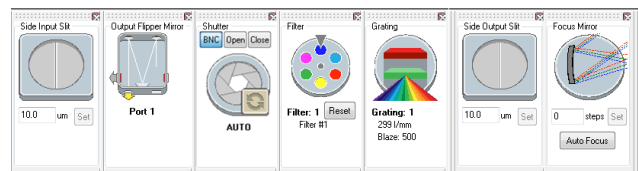

(a) (b) (c) (d) (e) (f) (g)

- (a and f) Slit drive: Control the spectrograph slit width - drag blades on icon or type in required slit width
- (b) Flipper motor: Used to select the appropriate exit port
- (c) Shutter: Synchronization mode selection for shutter operation
- (d) Filter wheel: Used to select a particular filter on the filter wheel - just click on the desired filter position
- (e) Grating turret: Used for setting grating turret to a new position and bringing desired grating in the optical path - just click on the desired grating
- (g) Adaptive focus: Used for automatic focus or user-controlled fine focus optimization

Product Dimensions

Dimensions in mm [inches]

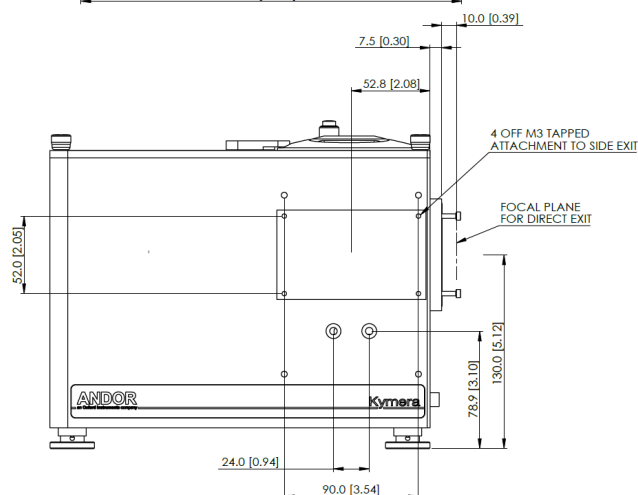
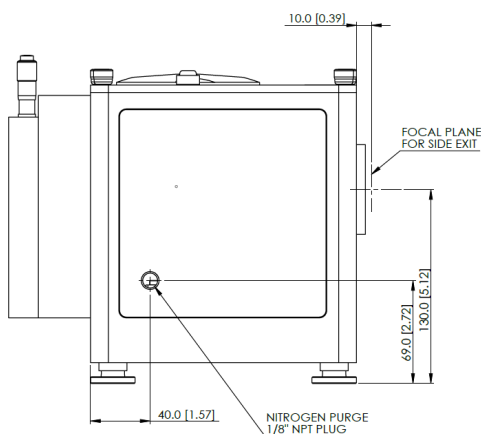
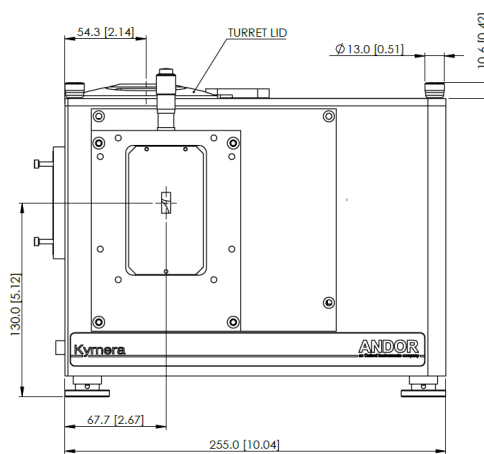
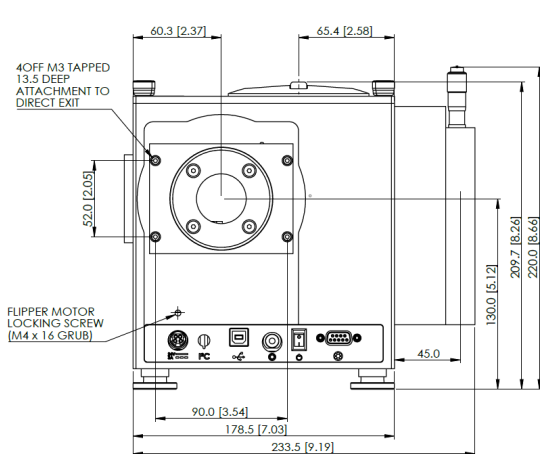

Optical Axis

Standard feet: Nominal optical axis height: 130 - 136 mm, increments of 6 mm with stackable spacer kit (SR-ASM-0098).

Standard configuration shown with manual slit on input, CCD flange on straight output.

Weight: 7.5 kg [16.5 lbs approx]

Connecting to the Kymera 193i

USB Control

Connector type: USB 'B' type

Shutter Control

Connector type: BNC Female, 50 Ω

Shutter Specifications

| | |
|-------------------------|----------------------------------|
| Maximum repetition rate | 40 Hz - burst; 10 Hz - sustained |
| Minimum open/close time | 6 ms |
| Minimum lifetime | 1 Million cycles |

Optical Property

| | | | | | | | |
|------------------------------|--|-----------------|----------------------|------------------|----------------------|------------------|----------------------|
| Focal plane size (mm, W x H) | 30 x 16 | | | | | | |
| Grating size (mm) | 50 x 50 | | | | | | |
| Stray light *16 | <table border="0"> <tr> <td>1 nm from laser</td> <td>3.8×10^{-4}</td> </tr> <tr> <td>10 nm from laser</td> <td>4.7×10^{-5}</td> </tr> <tr> <td>20 nm from laser</td> <td>8.9×10^{-6}</td> </tr> </table> | 1 nm from laser | 3.8×10^{-4} | 10 nm from laser | 4.7×10^{-5} | 20 nm from laser | 8.9×10^{-6} |
| 1 nm from laser | 3.8×10^{-4} | | | | | | |
| 10 nm from laser | 4.7×10^{-5} | | | | | | |
| 20 nm from laser | 8.9×10^{-6} | | | | | | |
| Magnification | 1.07:1 | | | | | | |

Wavelength Drive Performance

| | |
|--------------------------------|---------|
| Wavelength accuracy centre *17 | 0.15 nm |
| Wavelength repeatability *18 | 75 pm |

Wavelength Side Accuracy

| | |
|------------------------------|--------|
| Wavelength side accuracy *19 | 0.2 nm |
|------------------------------|--------|



Order Today

Need more information? At Andor we are committed to finding the correct solution for you. With a dedicated team of technical advisors, we are able to offer you one-to-one guidance and technical support on all Andor products. For a full listing of our local sales offices, please see: andor.com/contact

Our regional headquarters are:

Europe

Belfast, Northern Ireland
Phone +44 (28) 9023 7126
Fax +44 (28) 9031 0792

Japan

Tokyo
Phone +81 (3) 6732 8968
Fax +81 (3) 6732 8939

North America

Concord, MA, USA
Phone +1 (860) 290 9211
Fax +1 (860) 290 9566

China

Beijing
Phone +86 (10) 8271 9066
Fax +86 (10) 8271 9055

Items shipped with your spectrograph:

- 1x 3 m USB 2.0 cable Type A to Type B
- 1x Power supply (+24V, 5A) with 3 m mains cable
- 1x I²C to I²C cable
- 1x CD containing Andor user guides
- 1x Individual system performance booklet
- 1x CD containing either Solis software or SDK (if requested at time of order)
- 1x Allen key set (2 mm, 3 mm and 5 mm)

Regulatory Compliance

Compliant with the requirements of the EU EMC and LVD Directives, compliant with the international EMC and safety standards IEC 61326-1 and IEC 61010-1, and Machinery Directive 2006/42/EC.

Footnotes: Specifications are subject to change without notice

1. In the case of a multiple grating turret order, please specify desired grating configuration for each turret.
2. Shutter operation can be achieved directly through the I²C interface between cameras and spectrograph, or through a BNC-to-SMB cable when the spectrograph is operated through USB.
3. Typical values quoted with 27.6 mm wide CCD, e.g. Newton DU940.
4. Typical values quoted with 10 μm slit and 13.5 μm pixel CCD, e.g. Newton DU940.
5. Typical values quoted at 500 nm centre wavelength.
6. Typical values quoted at 300 nm centre wavelength.
7. Typical values quoted at maximum efficiency wavelength or blaze wavelength unless otherwise stated.
8. Wavelength within the recommended operating spectral region.
9. Indicative values; the working range of these gratings is principally in the region where optical aberrations may alter the system resolution performance quoted.
10. Useful signal is assumed to be imaged on the entire height of a 6.9 mm sensor (i.e. Newton DU940) and fully vertically binned.
11. Please refer to F/# matcher specification sheet for magnification considerations.
12. Please refer to the local sales representative or website for further information on available options and complimentary accessories.
13. Slit widths range from 10 μm to 2.5 mm.
14. Provided as standard.
15. Recommended for use with fibre-optics and C-mount accessories.
16. Measured with a 633 nm laser and a 1200 l/mm grating for Full Vertical Binning (FVB) on a 6.9 mm high sensor, and a 1 mm strip vertically centred on the optical axis.
17. Average measurements using > 30 calibration lines, covering the recommended grating angle operating range with a 1200 l/mm grating.
18. The standard deviation of 20 measurements of a peak's centre-of-mass position: between each measurement the drive is moved 10x including both wavelength and grating changes to reflect typical use.
19. Side accuracy measured using a 27.6 mm wide sensor, reflecting the dispersion calibration and step-and-glue accuracy.
20. Only Andor CCD platforms (Newton, iDus, iKon) can be controlled in conjunction with Kymera and Shamrock spectrographs in EPICS software.



Minimum Computer Requirements:

- 3.0 GHz single core or 2.4 GHz multi core processor
- 2 GB RAM
- 100 MB free hard disc to install software (at least 1 GB recommended for data spooling)
- USB 2.0 High Speed Host Controller capable of sustained rate of 40 MB/s
- Windows (7, 8, 8.1 and 10)

Operating and Storage Conditions

- Operating Temperature: 0°C to 30°C ambient
- Relative Humidity: < 70% (non-condensing)
- Storage Temperature: -25°C to 50°C

Power Requirements

- 100 - 240 VAC 50 - 60 Hz
- Max. power consumption: 21 W (10 Hz shutter and grating turret operation)



Windows is a registered trademark of Microsoft Corporation. Labview is a registered trademark of National Instruments. Matlab is a registered trademark of The MathWorks Inc.